

MOEN®

INSTALLATION INSTRUCTIONS

THESE INSTRUCTIONS MUST BE
LEFT WITH HOMEOWNER

TWO-HANDLE LAVATORY FAUCETS

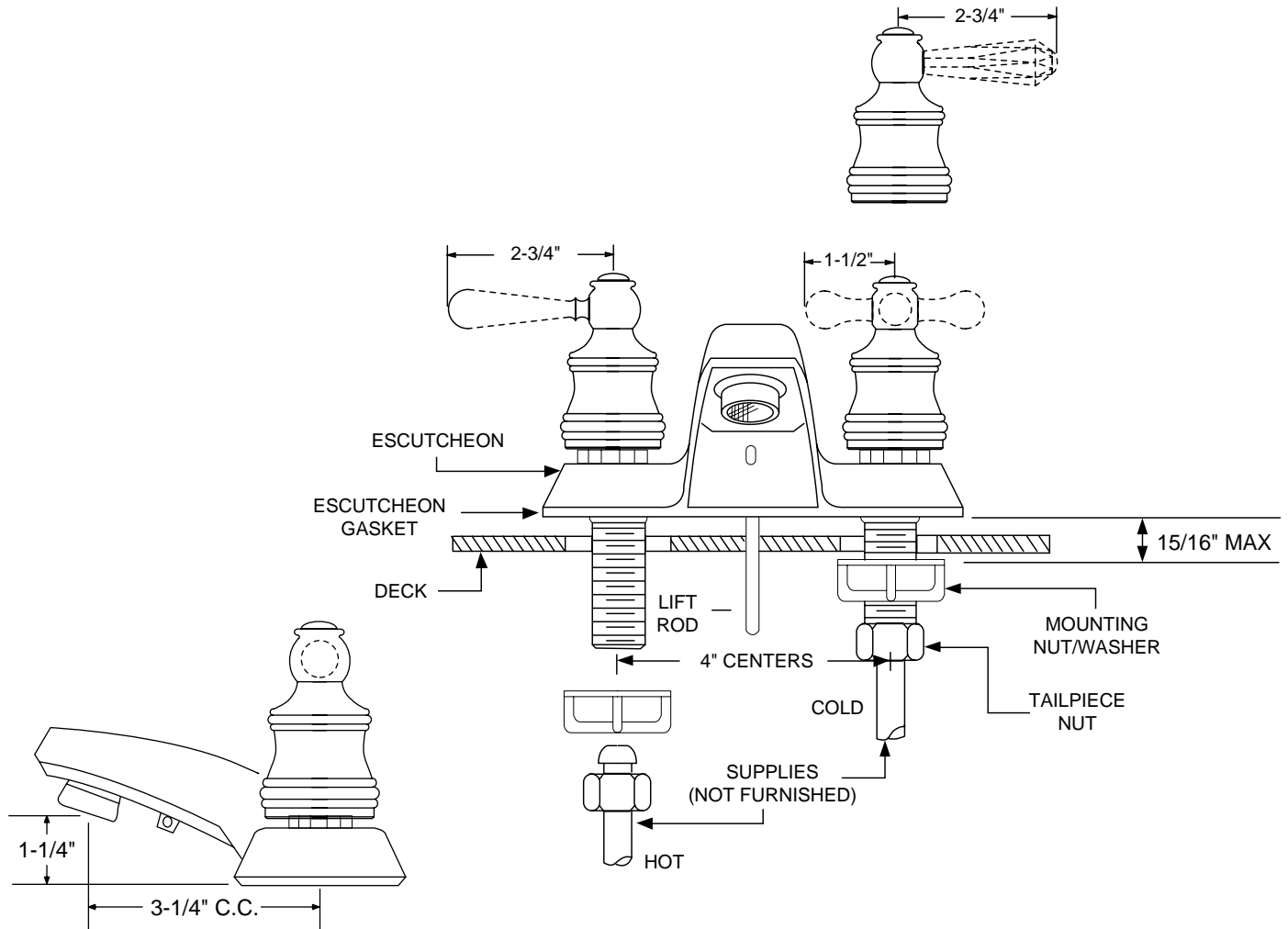

Complies with ASEM A112.18.1M and CSA B125

CAUTION: Always turn water OFF before disassembling the faucet. Open faucet handles to relieve water pressure and to insure that COMPLETE water shut-off has been accomplished.

Before turning water on during either rough-in or trim-out, make sure that cartridge retainer nuts are in place. The cartridge and cartridge retainer nuts were properly installed and tested before leaving the factory. Although it is unlikely, it is nevertheless possible that through the handling of the valve by any number of persons the cartridge retainer nuts may not be properly installed. This should be carefully checked at time of rough-in and trim-out. If the cartridge retainer nuts are not properly installed, water pressure could force the cartridge out of the faucet body. Personal injury or water damage to the premises could result.

Faucet Installation

1. Be sure basin is clean and dry. Place a 3/8" bead of plumbers putty (not furnished) on underside of deck gasket. Place faucet supplies down through holes. Position faucet.
2. To fasten faucet on basin: Adjust the position of the faucet on the basin to best accommodate bowl size. From under the sink, place the mounting nut/washers on the faucet supplies, large side up. Thread on mounting nut/washers by hand. Check faucet position. Align and match escutcheon and escutcheon gasket together. Make final tightening of the mounting nut/washers by hand.

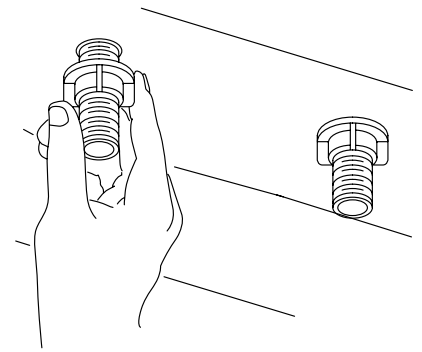

HANDLE INSERT INSTALLATION:

1. Be sure O-ring is in place on insert as shown.
2. Screw insert into handle hub.
3. Insert handle screw and snap plug button into place.

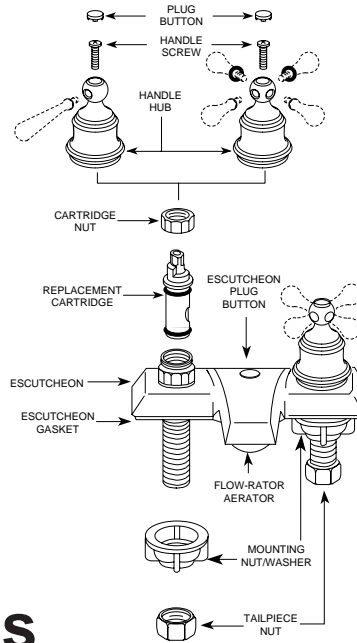

Flushing Instructions

IMPORTANT: Pipe chips, sand, stones, and other solid objects found in new and renovated plumbing can damage the sealing surface of the faucet cartridge and cause a leak. To avoid damage, **DO NOT OPERATE VALVE** until you have followed these instructions.

1. After installing and connecting your new faucet, turn on both supply valves and look for any leaks.
2. At the valve turn on both hot and cold water and allow the water to run for 15 seconds.
3. Turn off the water, unscrew the aerator from the end of spout and clean any debris from the cone screen.
4. Replace the aerator.

Disassembly

CAUTION: Turn OFF BOTH water supplies and open BOTH faucet handles to alleviate water pressure to insure that COMPLETE water shut-off has been accomplished.

These instructions apply to both the hot and cold sides. Parts and procedures are the same for each side.

1. Use a flat tool. Pry off the plug button.
2. Remove the handle screw using a screwdriver.
3. Pull the handle up and off.
4. Unscrew the cartridge nut using a wrench.
5. Using pliers, pull cartridge straight up, by the cartridge stem (see illustration).

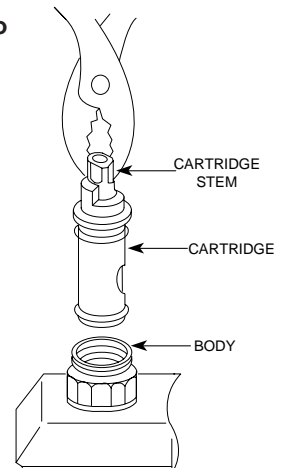

Reassembly

CAUTION: Failure to follow these instructions can cause personal injury or water damage to the premises, or could result in a faulty installation or damage the new cartridge.

1. Rotate the cartridge stem so hole in piston lines up with hole in outer shell.
2. Push the cartridge straight down into the body. Fit the key on the cartridge into the notch in the body. This will position the handle stop on the cartridge to the side, as shown.
3. Screw down the cartridge nut. Start by hand and **DO NOT CROSS THREAD**. Tighten firmly with wrench.
4. **CAUTION:** Make sure that the cartridge and cartridge nut on the opposite side are completely assembled into the faucet.
5. Rotate cartridge stem to the off position, as shown. For both cross and lever handle models the handle lug must face the front of the faucet in the off position as shown.
6. Now the handle hub can be installed. (NOTE: for lever handle models, see illustration). Match the flats in the handle hub with the flats on the cartridge stem and place the handle hub down on the stem.
7. Screw in the handle screw, snug. Do not overtighten. Press the plug button into place.

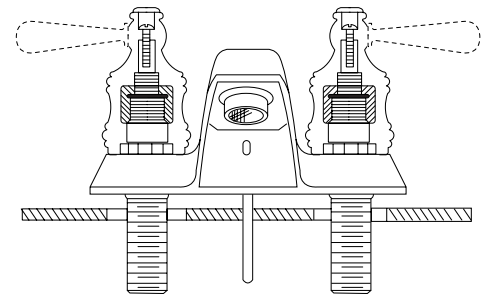
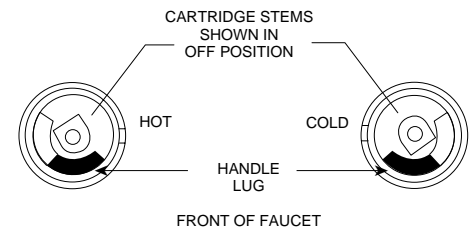
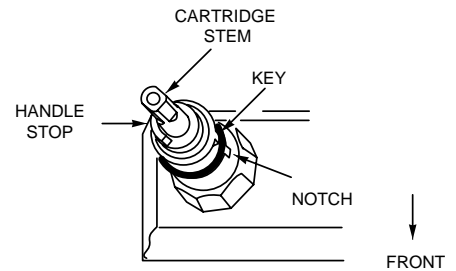

Install lever handles as shown above. Each handle should rotate inward towards spout.

CAUTION: Shut OFF faucet handles before opening water supplies to prevent accidental flooding.

Lavatory Lift Rod and Waste Assembly

1. Thoroughly clean around drain opening in lavatory sink. Apply 1/4" bead of plumber's putty (not furnished) around the bottom side of drain seat (as shown).
2. Apply pipe joint compound (not furnished) to top threaded end of the drain body. Slip drain body up through the drain opening and screw seat onto the drain body.
3. Position the drain body (with pivot rod opening extending rearward) and tighten mounting nut until the drain body is snug. Wipe excess plumber's putty from the drain seat area. Apply pipe joint compound (not furnished) to top threaded end of tailpipe and screw into drain body. Tighten firmly by hand.
4. Position drain plug in either of the following ways:
 - A. **VANDALPROOF** - This design is to prevent unauthorized removal of the drain plug. Unscrew the pivot nut and remove the pivot rod. Inside the drain body position the pivot rod through the drain plug hole as shown in the illustration below. Screw the pivot nut back on the drain body. **DO NOT OVERTIGHTEN.**
 - B. **EASY REMOVAL** - This design is for quick removal of drain plug for cleaning. Just drop in the drain plug as shown in the illustration below.

A. VANDALPROOF

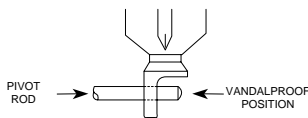

B. EASY REMOVAL

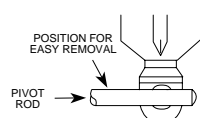

5. Install lift rod, with knob attached, into top of spout as shown. Secure lift rod strap to bottom end of lift rod as shown. With pivot rod in the down position, assemble strap to pivot rod using the spring clip. The strap will have to be bent to reach the pivot rod on some installation. Adjustment may be required so lift rod clears spout tube and connection.
6. With the drain plug in full open position, adjust lift rod and knob to clear faucet and tighten lift rod strap screw.

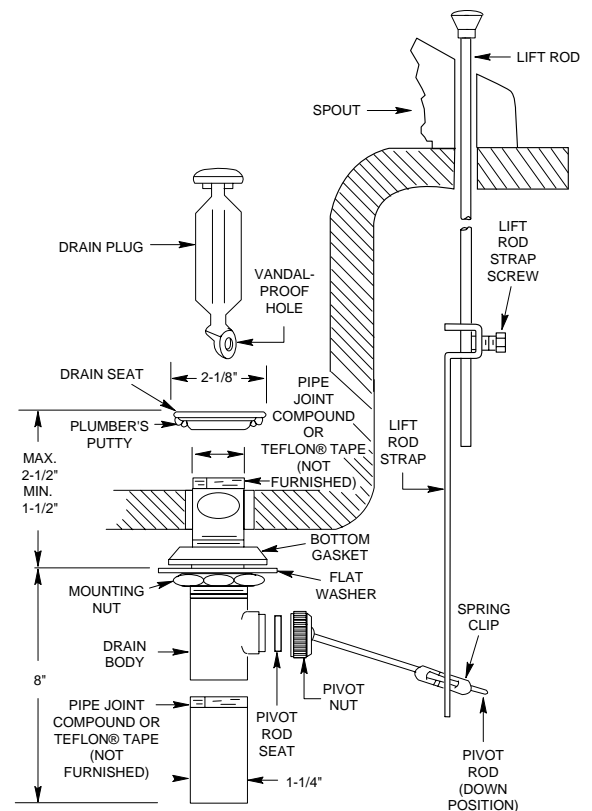

Consumer Information

Faucets made of leaded brass alloys may contribute small amounts of lead to water that is allowed to stand in contact with the brass. The amount of lead contributed by any faucet is highest when the faucet is new. The following steps may reduce potential exposure to lead from faucets and other parts of the plumbing system:

- Always run the water for a few seconds prior to use for drinking or cooking.
- Use only cold water for drinking or cooking.
- If you wish to flush the entire plumbing system of water that has been standing in the pipes or other fittings, run the cold water until the temperature of the water drops, indicating water coming from the outside main.
- If you are concerned about lead in your water, have your water tested by a certified laboratory in your area.

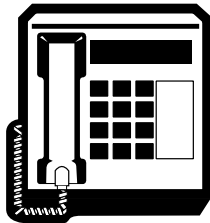

HELPLINE:

For answers to any product, installation, replacement parts or warranty questions, call our consumer helplines.

In the U.S., toll free:
1-800-321-6636

In Canada call:
Toronto, 905-829-3400
Rest of Canada, 1-800-465-6130



Moen Incorporated 25300 Al Moen Drive, North Olmsted, OH 44070-8022, U.S.A.
In Canada:
Moen Inc. 2816 Bristol Circle, Oakville, Ontario L6H5S7

© Copyright 1995
Moen Incorporated
Printed in U.S.A.