

MOEN® **INSTALLATION INSTRUCTIONS**
 THESE INSTRUCTIONS MUST BE LEFT WITH HOMEOWNER

LEVER & CROSS HANDLE WIDESPREAD LAVATORY MODELS

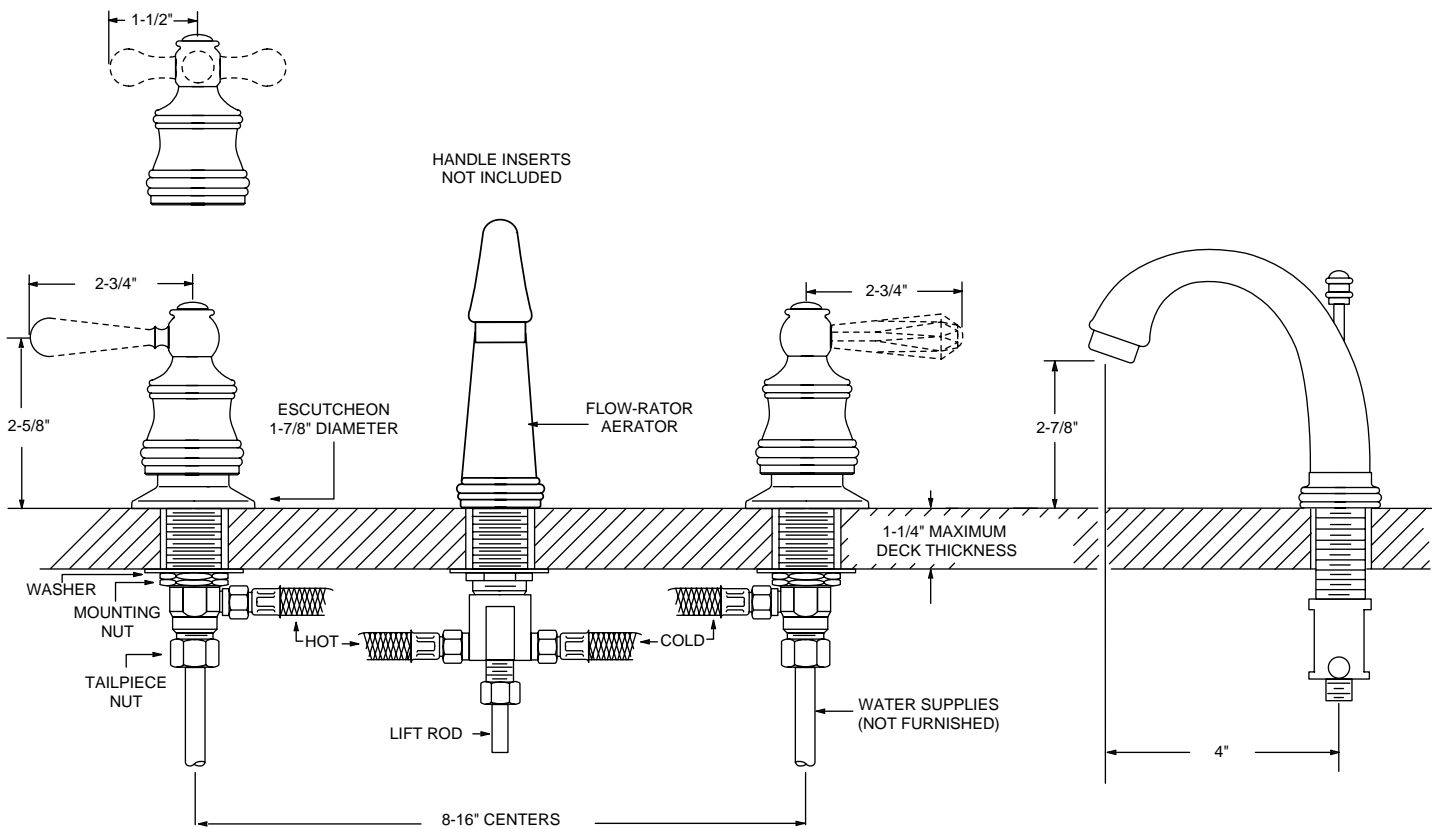

Complies with ASME A112.18.1M and CSA B125

SPOUT INSTALLS THROUGH 1" MIN. DIAMETER HOLE.
 VALVE INSTALLS THROUGH 1-1/8" MIN. DIAMETER HOLE.

CAUTION: Always turn water OFF before disassembling the faucet. Open faucet handles to relieve water pressure and to insure that COMPLETE water shut-off has been accomplished.

Before turning water on during either rough-in or trim-out, make sure the cartridge retainer nuts are in place. The cartridges and cartridge retainer nuts were properly installed and tested before leaving the factory. Although it is unlikely, it is nevertheless possible that through the handling of the faucet by any number of persons the cartridge retainer nuts may not be properly installed. This should be carefully checked at time of rough-in and trim-out. If the cartridge retainer nuts are not properly installed, water pressure could force the cartridge out of the faucet body. Personal injury or water damage to the premises could result.

Installation Instructions

1. Fill the recess under the spout and handle escutcheons with plumber's putty (not furnished). Place spout with spout escutcheon in place down through the center hole. Put spout mounting washer over spout shank. Screw on the spout mounting nut and make hand-tight.
2. Turn bottom mounting nuts on valve bodies all the way down, for basin clearance, and drop on mounting washers. With the valve bodies and supply tubing assembled under the sink, slide the bodies up through the holes. Screw top mounting nuts down until top of valve bodies are $3/8"$ to $7/16"$ from top of deck (see illustration below).

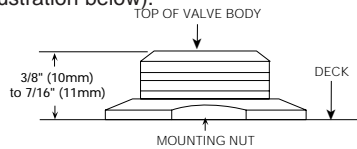

NOTE: To properly install handle escutcheon and handle, valve bodies must be above deck at dimensions shown.

3. Screw the handle escutcheons onto valve bodies and hand-tighten them until they bottom out. Screw the bottom mounting nuts and mounting washers up against the bottom of the basin and hand-tighten. Hold the valve bodies from turning by using another wrench on valve body flats. Install supply tubing to spout union tee.
4. Screw handle inserts (not furnished) into handle hubs, temporarily install handle hubs without screws and rotate hot side clockwise and cold side counterclockwise until they stop. To adjust handle orientation; note handle position, remove handle, pull up on the upper handle adapter, replace the handle without screw and turn to the desired position, push down on handle hub to reengage the upper and lower handle adapter, install handle screw and tighten firmly, now install plug buttons.
5. Install waste assembly see Lavatory Lift Rod and Waste Assembly then connect valve bodies to water supply lines, do not turn on water at this time, faucet flushing is required see Flushing Instructions.
If handle rotation is reversed see Disassembly, note CAUTION, and follow steps 1 and 2 then lift up and turn the lower handle adapter 180° and replace. Replace upper handle adapter, replace cartridge nut and stem guide as instructed in step 4 of Reassembly, check handle orientation and reinstall handle parts.

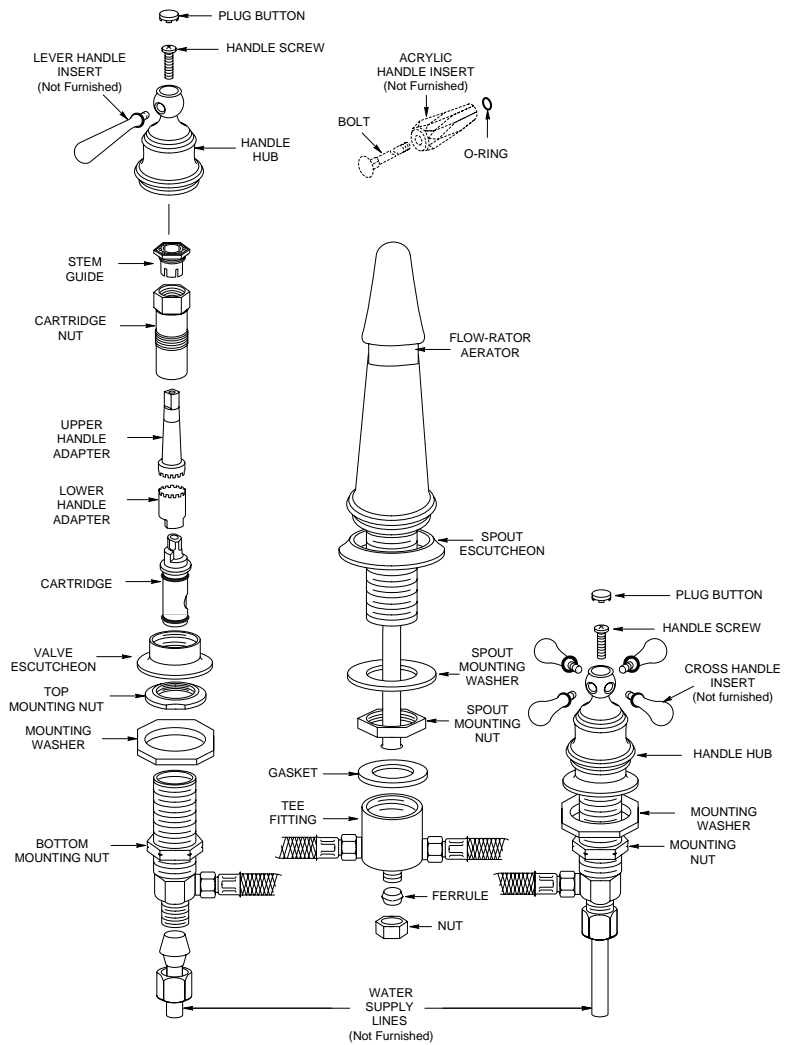

Flushing Instructions

IMPORTANT: Pipe chips, sand, stones, and other solid objects found in new and renovated plumbing can damage the sealing surface of the faucet cartridge and cause a leak. To avoid damage, DO NOT TURN ON SUPPLY VALVES until instructed below.

1. After installing and connecting your new faucet, open both hot and cold cartridges.
2. Turn on both hot and cold water supply valves and allow the water to run for 15 seconds.
3. Turn off the hot and cold cartridges, unscrew the aerator from the end of spout and clean any debris from the cone screen.
4. Replace the aerator and check the system for leaks.

Disassembly

CAUTION: Turn OFF BOTH water supplies and open BOTH faucet handles to alleviate water pressure and to insure that COMPLETE water shut-off has been accomplished.

1. Remove plug button, handle screw and handle hub.
2. Loosen the cartridge nut with an adjustable wrench and remove it and the stem guide as a unit together with the upper handle adapter.
3. Set aside the cartridge nut and stem guide and with the handle adapter installed, reassemble handle hub with handle screw and tighten.
4. Grasp handle hub in the middle and pull cartridge STRAIGHT UP and out of the valve body.

Reassembly

CAUTION: Failure to follow these instructions can cause personal injury or water damage to the premises, or could result in a faulty installation or damage the new cartridge.

1. With cartridge nut removed, assemble the handle adapter and handle hub to the new cartridge and tighten the handle screw. This will aid in locating the cartridge properly in the valve body. Turn the cartridge stem so the hole in the piston is lined up with the hole in the shell.
2. Drop the cartridge into the valve body and press down.
3. Now press down firmly while rotating handle counterclockwise. This will align the "KEY" on the cartridge with the "NOTCH" in the valve body. When the key enters the notch you will feel it drop in and the cartridge will be in place. To be certain, rotate the handle clockwise and then counterclockwise with gentle force. You should feel the handle stop in both directions. If so, the cartridge is in place. **Do not turn the water on yet.**
4. Remove handle screw and handle hub, install cartridge nut with stem guide over the upper handle adapter, start by hand DO NOT CROSS THREAD. Firmly tighten cartridge nut and stem guide using adjustable wrench.
5. Reinstall handle hubs, screws and plug buttons (follow illustration on previous page). You are now ready to turn the water back on.

TO INSTALL HANDLE INSERTS

1. Be sure o-ring is in place on insert at shown.
2. Screw insert(s) into handle hub.

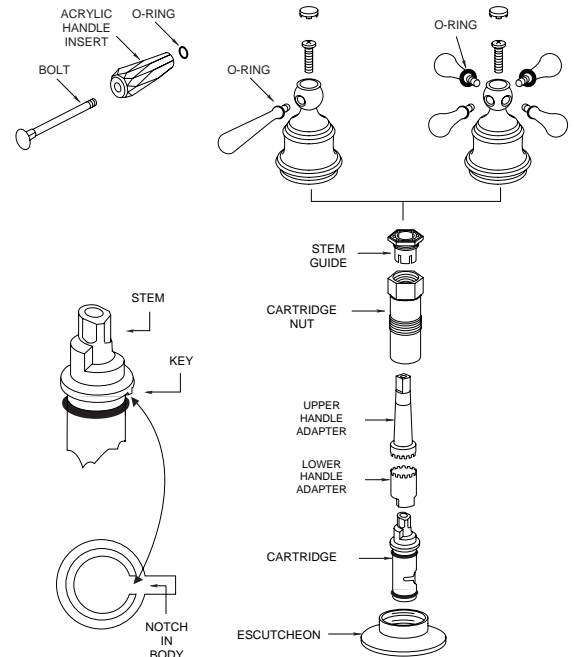

Lavatory Lift Rod and Waste Assembly

1. Thoroughly clean around drain opening in lavatory sink. Apply 1/4 inch bead of plumber's putty (not furnished) around the bottom side of drain seat (as shown).
2. Apply pipe joint compound (not furnished) to top threaded end of the drain body. Slip drain body up through the drain opening and screw seat onto the drain body.
3. Position the drain body (with pivot rod opening extending rearward) and tighten mounting nut until the drain body is snug. Wipe excess plumber's putty from the drain seat area. Apply pipe joint compound (not furnished) to top threaded end of tailpipe and screw into drain body. Tighten firmly by hand.
4. Position drain plug in either of the following ways:
 - A. VANDALPROOF - This design is to prevent unauthorized removal of the drain plug. Unscrew the pivot nut and remove the pivot rod. Inside the drain body position the pivot rod through the drain plug hole as shown in the illustration below. Screw the pivot nut back on the drain body. **DO NOT OVERTIGHTEN.**
 - B. EASY REMOVAL - This design is for quick removal of drain plug for cleaning. Just drop in the drain plug as shown in the illustration below.

A. VANDALPROOF

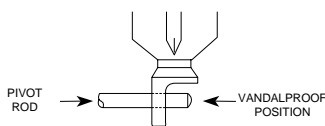

B. EASY REMOVAL

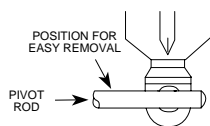

5. Install lift rod, with knob attached, into top of spout as shown. Secure lift rod strap to bottom end of lift rod as shown. With pivot rod in the down position, assemble strap to pivot rod using the spring clip. The strap will have to be bent to reach the pivot rod on some installations. Adjustment may be required so lift rod clears spout tube and connection.
6. With the drain plug in full open position, adjust lift rod and knob to clear faucet and tighten lift rod strap screw.

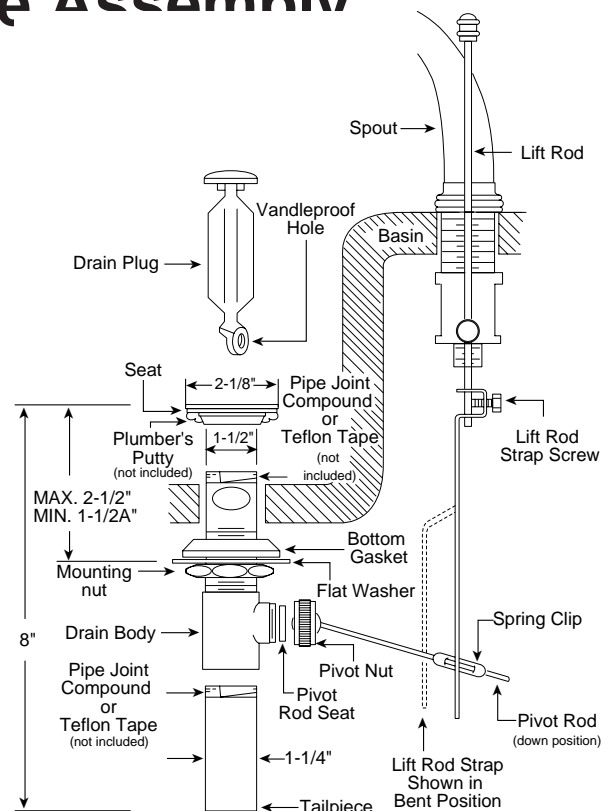

Consumer Information

Faucets made of leaded brass alloys may contribute small amounts of lead to water that is allowed to stand in contact with the brass. The amount of lead contributed by any faucet is highest when the faucet is new. The following steps may reduce potential exposure to lead from faucets and other parts of the plumbing system:

- Always run the water for a few seconds prior to use for drinking or cooking.
- Use only cold water for drinking or cooking.
- If you wish to flush the entire plumbing system of water that has been standing in the pipes or other fittings, run the cold water until the temperature of the water drops, indicating water coming from the outside main.
- If you are concerned about lead in your water, have your water tested by a certified laboratory in your area.

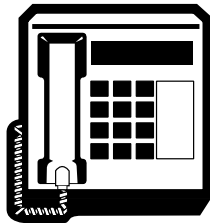

HELPLINE:

For answers to any product, installation, replacement parts or warranty questions, call our consumer helplines.

In the U.S., toll free:

1-800-321-6636

In Canada call:

Toronto, 905-829-3400

Rest of Canada, 1-800-465-6130



Moen Incorporated 25300 Al Moen Drive, North Olmsted, OH 44070-8022, U.S.A.

In Canada:

Moen Inc. 2816 Bristol Circle, Oakville, Ontario L6H5S7

© Copyright 1995
Moen Incorporated
Printed in U.S.A.